

# SN74LS00

## Quad 2-Input NAND Gate

- ESD > 3500 Volts

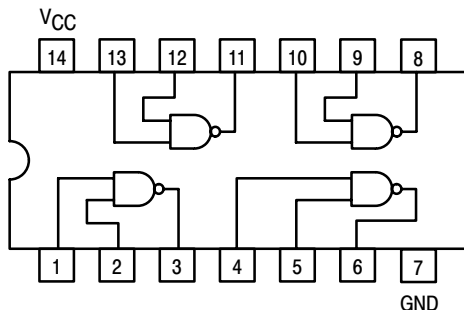

### GUARANTEED OPERATING RANGES

Symbol	Parameter	Min	Typ	Max	Unit
$V_{CC}$	Supply Voltage	4.75	5.0	5.25	V
$T_A$	Operating Ambient Temperature Range	0	25	70	°C
$I_{OH}$	Output Current – High			-0.4	mA
$I_{OL}$	Output Current – Low			8.0	mA



ON Semiconductor™

<http://onsemi.com>

LOW  
POWER  
SCHOTTKY

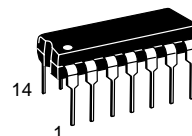

PLASTIC  
N SUFFIX  
CASE 646

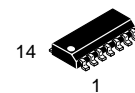

SOIC  
D SUFFIX  
CASE 751A

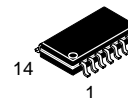

SOEIAJ  
M SUFFIX  
CASE 965

### ORDERING INFORMATION

Device	Package	Shipping
SN74LS00N	14 Pin DIP	2000 Units/Box
SN74LS00D	SOIC-14	55 Units/Rail
SN74LS00DR2	SOIC-14	2500/Tape & Reel
SN74LS00M	SOEIAJ-14	See Note 1
SN74LS00MEL	SOEIAJ-14	See Note 1

1. For ordering information on the EIAJ version of the SOIC package, please contact your local ON Semiconductor representative.

# SN74LS00

## DC CHARACTERISTICS OVER OPERATING TEMPERATURE RANGE (unless otherwise specified)

Symbol	Parameter	Limits			Unit	Test Conditions
		Min	Typ	Max		
$V_{IH}$	Input HIGH Voltage	2.0			V	Guaranteed Input HIGH Voltage for All Inputs
$V_{IL}$	Input LOW Voltage			0.8	V	Guaranteed Input LOW Voltage for All Inputs
$V_{IK}$	Input Clamp Diode Voltage		-0.65	-1.5	V	$V_{CC} = \text{MIN}$ , $I_{IN} = -18 \text{ mA}$
$V_{OH}$	Output HIGH Voltage	2.7	3.5		V	$V_{CC} = \text{MIN}$ , $I_{OH} = \text{MAX}$ , $V_{IN} = V_{IH}$ or $V_{IL}$ per Truth Table
$V_{OL}$	Output LOW Voltage		0.25	0.4	V	$I_{OL} = 4.0 \text{ mA}$
			0.35	0.5	V	$I_{OL} = 8.0 \text{ mA}$
$I_{IH}$	Input HIGH Current			20	$\mu\text{A}$	$V_{CC} = \text{MAX}$ , $V_{IN} = 2.7 \text{ V}$
				0.1	mA	$V_{CC} = \text{MAX}$ , $V_{IN} = 7.0 \text{ V}$
$I_{IL}$	Input LOW Current			-0.4	mA	$V_{CC} = \text{MAX}$ , $V_{IN} = 0.4 \text{ V}$
$I_{OS}$	Short Circuit Current (Note 2)	-20		-100	mA	$V_{CC} = \text{MAX}$
$I_{CC}$	Power Supply Current Total, Output HIGH Total, Output LOW			1.6	mA	$V_{CC} = \text{MAX}$
				4.4		

2. Not more than one output should be shorted at a time, nor for more than 1 second.

## AC CHARACTERISTICS ( $T_A = 25^\circ\text{C}$ )

Symbol	Parameter	Limits			Unit	Test Conditions
		Min	Typ	Max		
$t_{PLH}$	Turn-Off Delay, Input to Output		9.0	15	ns	$V_{CC} = 5.0 \text{ V}$ $C_L = 15 \text{ pF}$
$t_{PHL}$	Turn-On Delay, Input to Output		10	15	ns	

# SN74LS00

## PACKAGE DIMENSIONS

### N SUFFIX PLASTIC PACKAGE CASE 646-06 ISSUE M

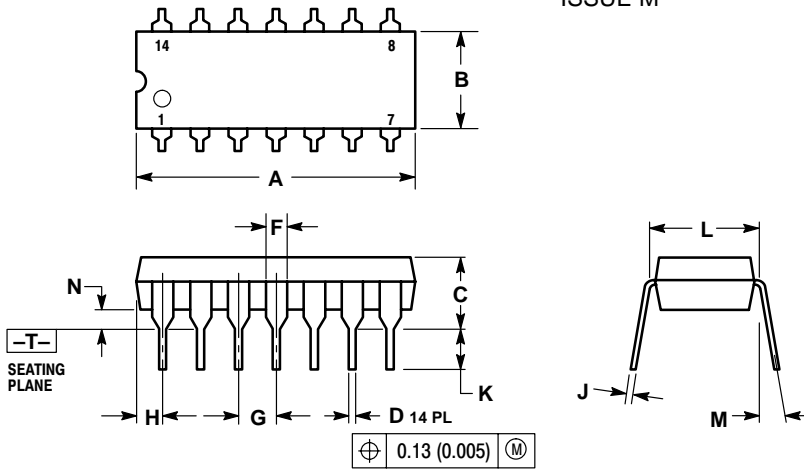

NOTES:

1. DIMENSIONING AND TOLERANCING PER ANSI Y14.5M, 1982.
2. CONTROLLING DIMENSION: INCH.
3. DIMENSION L TO CENTER OF LEADS WHEN FORMED PARALLEL.
4. DIMENSION B DOES NOT INCLUDE MOLD FLASH.
5. ROUNDED CORNERS OPTIONAL.

DIM	INCHES		MILLIMETERS	
	MIN	MAX	MIN	MAX
A	0.715	0.770	18.16	18.80
B	0.240	0.260	6.10	6.60
C	0.145	0.185	3.69	4.69
D	0.015	0.021	0.38	0.53
F	0.040	0.070	1.02	1.78
G	0.100 BSC 2.54 BSC			
H	0.052	0.095	1.32	2.41
J	0.008	0.015	0.20	0.38
K	0.115	0.135	2.92	3.43
L	0.290	0.310	7.37	7.87
M	---	10°	---	10°
N	0.015	0.039	0.38	1.01

### D SUFFIX PLASTIC SOIC PACKAGE CASE 751A-03 ISSUE F

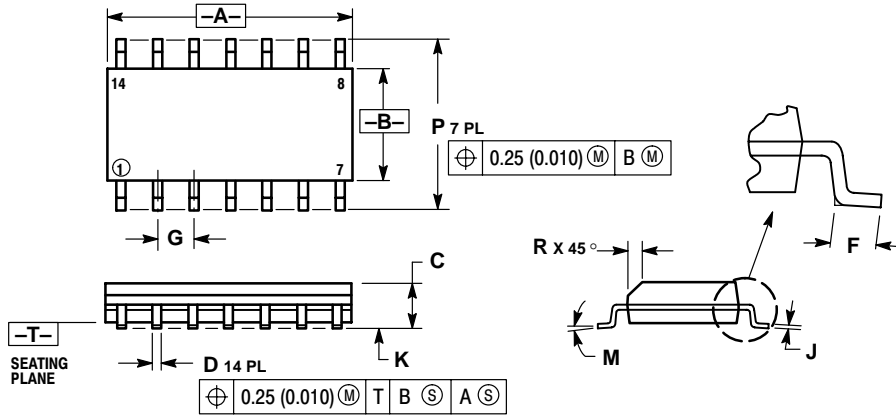

NOTES:

1. DIMENSIONING AND TOLERANCING PER ANSI Y14.5M, 1982.
2. CONTROLLING DIMENSION: MILLIMETER.
3. DIMENSIONS A AND B DO NOT INCLUDE MOLD PROTRUSION.
4. MAXIMUM MOLD PROTRUSION 0.15 (0.006) PER SIDE.
5. DIMENSION D DOES NOT INCLUDE DAMBAR PROTRUSION. ALLOWABLE DAMBAR PROTRUSION SHALL BE 0.127 (0.005) TOTAL IN EXCESS OF THE D DIMENSION AT MAXIMUM MATERIAL CONDITION.

DIM	MILLIMETERS		INCHES	
	MIN	MAX	MIN	MAX
A	8.55	8.75	0.337	0.344
B	3.80	4.00	0.150	0.157
C	1.35	1.75	0.054	0.068
D	0.35	0.49	0.014	0.019
F	0.40	1.25	0.016	0.049
G	1.27 BSC		0.050 BSC	
J	0.19	0.25	0.008	0.009
K	0.10	0.25	0.004	0.009
M	0°	7°	0°	7°
P	5.80	6.20	0.228	0.244
R	0.25	0.50	0.010	0.019

# SN74LS00

## PACKAGE DIMENSIONS

**M SUFFIX**  
**SOEIAJ PACKAGE**  
**CASE 965-01**  
**ISSUE O**

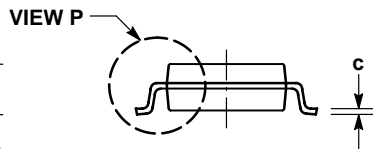
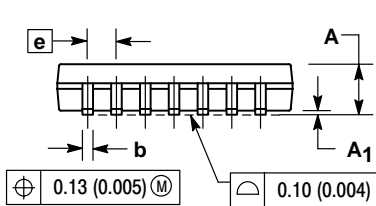
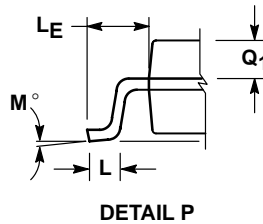
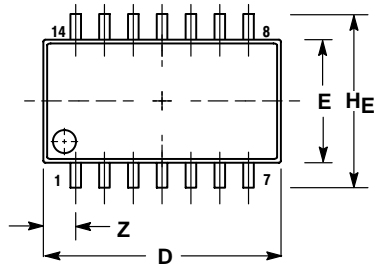

**NOTES:**

1. DIMENSIONING AND TOLERANCING PER ANSI Y14.5M, 1982.
2. CONTROLLING DIMENSION: MILLIMETER.
3. DIMENSIONS D AND E DO NOT INCLUDE MOLD FLASH OR PROTRUSIONS AND ARE MEASURED AT THE PARTING LINE. MOLD FLASH OR PROTRUSIONS SHALL NOT EXCEED 0.15 (0.006) PER SIDE.
4. TERMINAL NUMBERS ARE SHOWN FOR REFERENCE ONLY.
5. THE LEAD WIDTH DIMENSION (b) DOES NOT INCLUDE DAMBAR PROTRUSION. ALLOWABLE DAMBAR PROTRUSION SHALL BE 0.08 (0.003) TOTAL IN EXCESS OF THE LEAD WIDTH DIMENSION AT MAXIMUM MATERIAL CONDITION. DAMBAR CANNOT BE LOCATED ON THE LOWER RADIUS OR THE FOOT. MINIMUM SPACE BETWEEN PROTRUSIONS AND ADJACENT LEAD TO BE 0.46 (0.018).

DIM	MILLIMETERS		INCHES	
	MIN	MAX	MIN	MAX
A	---	2.05	---	0.081
A <sub>1</sub>	0.05	0.20	0.002	0.008
b	0.35	0.50	0.014	0.020
c	0.18	0.27	0.007	0.011
D	9.90	10.50	0.390	0.413
E	5.10	5.45	0.201	0.215
e	1.27 BSC		0.050 BSC	
H <sub>E</sub>	7.40	8.20	0.291	0.323
0.50	0.50	0.85	0.020	0.033
L <sub>F</sub>	1.10	1.50	0.043	0.059
M	0 °	10 °	0 °	10 °
Q <sub>1</sub>	0.70	0.90	0.028	0.035
Z	---	1.42	---	0.056

**ON Semiconductor** and  are trademarks of Semiconductor Components Industries, LLC (SCILLC). SCILLC reserves the right to make changes without further notice to any products herein. SCILLC makes no warranty, representation or guarantee regarding the suitability of its products for any particular purpose, nor does SCILLC assume any liability arising out of the application or use of any product or circuit, and specifically disclaims any and all liability, including without limitation special, consequential or incidental damages. "Typical" parameters which may be provided in SCILLC data sheets and/or specifications can and do vary in different applications and actual performance may vary over time. All operating parameters, including "Typicals" must be validated for each customer application by customer's technical experts. SCILLC does not convey any license under its patent rights nor the rights of others. SCILLC products are not designed, intended, or authorized for use as components in systems intended for surgical implant into the body, or other applications intended to support or sustain life, or for any other application in which the failure of the SCILLC product could create a situation where personal injury or death may occur. Should Buyer purchase or use SCILLC products for any such unintended or unauthorized application, Buyer shall indemnify and hold SCILLC and its officers, employees, subsidiaries, affiliates, and distributors harmless against all claims, costs, damages, and expenses, and reasonable attorney fees arising out of, directly or indirectly, any claim of personal injury or death associated with such unintended or unauthorized use, even if such claim alleges that SCILLC was negligent regarding the design or manufacture of the part. SCILLC is an Equal Opportunity/Affirmative Action Employer.

### PUBLICATION ORDERING INFORMATION

**Literature Fulfillment:**

Literature Distribution Center for ON Semiconductor  
P.O. Box 5163, Denver, Colorado 80217 USA  
**Phone:** 303-675-2175 or 800-344-3860 Toll Free USA/Canada  
**Fax:** 303-675-2176 or 800-344-3867 Toll Free USA/Canada  
**Email:** ONlit@hibbertco.com

**N. American Technical Support:** 800-282-9855 Toll Free USA/Canada

**JAPAN:** ON Semiconductor, Japan Customer Focus Center  
4-32-1 Nishi-Gotanda, Shinagawa-ku, Tokyo, Japan 141-0031  
**Phone:** 81-3-5740-2700  
**Email:** r14525@onsemi.com

**ON Semiconductor Website:** <http://onsemi.com>

For additional information, please contact your local Sales Representative.